

Assembly doctor for LGTM

Design by Carl Hagerling for Dark

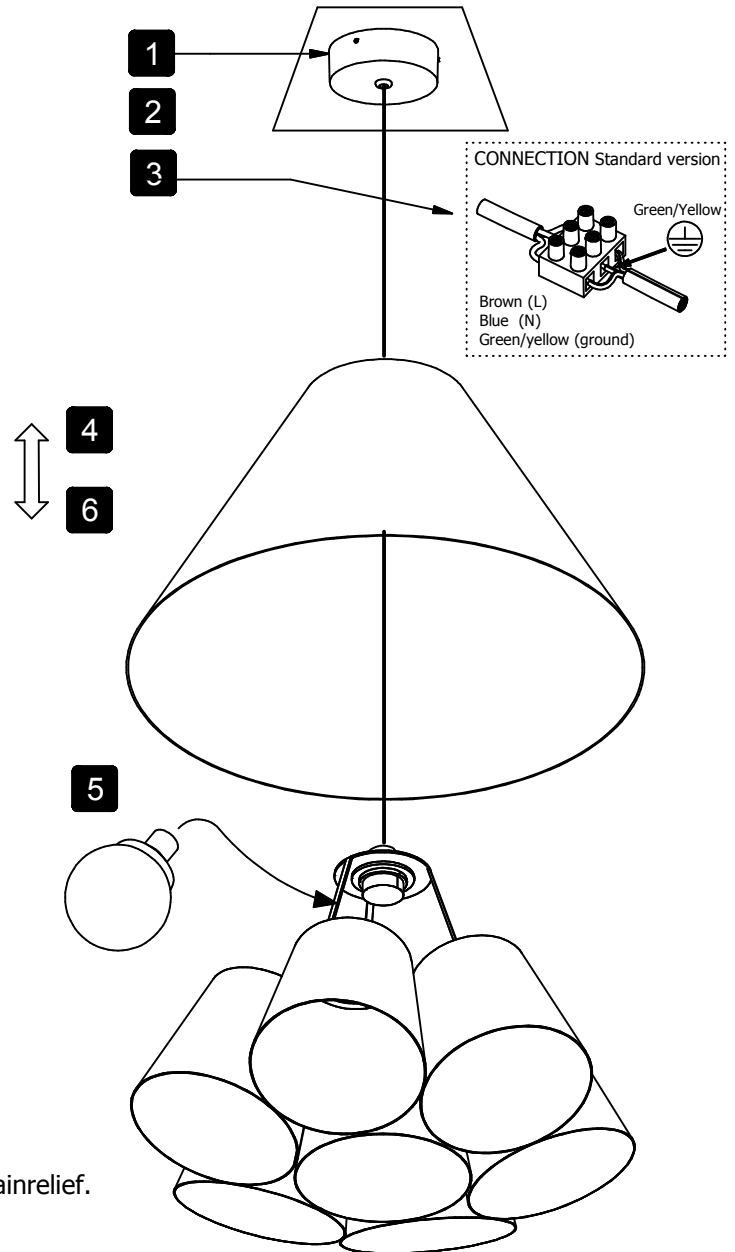

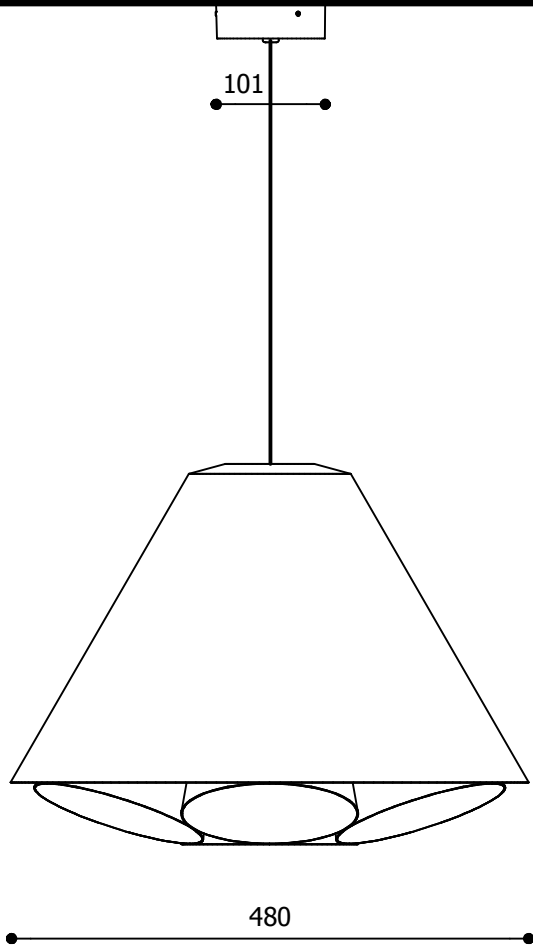

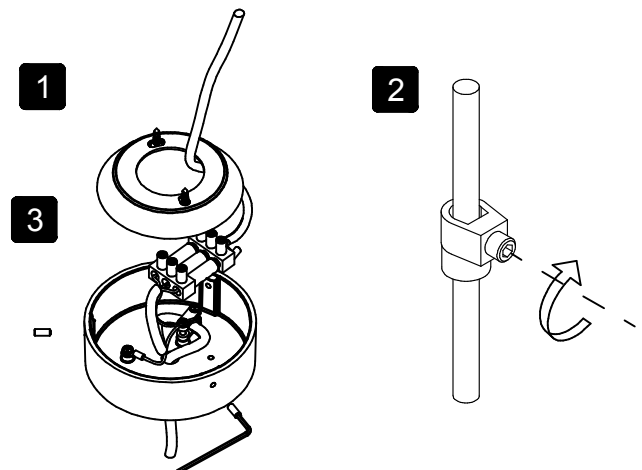

1. Mount the ceiling bracket with 2 screws onto the ceiling.
2. Adjust the fixture to the preferred height and fasten the strainrelief.
3. Connect the power supply and close the ceiling base.
4. To (re)place the lamps, raise the outer lampshade.
5. Insert the lamp. Respect the wattage of the fixture.
6. Lower the outer lampshade.









DARK <<
www.dark.be

Dark at night
Vliegplein 43 - 9991 Maldegem
Belgium - Europe

tel +32(0)50/71.81.40
fax +32(0)50/71.81.38
mail info@dark.be

1x		TCG-SE	max 15 Watt	E27
1x		LED	max 11 Watt	E27
		5 kg		

	230 V		0.3m		960 °C		IP20		
---	-------	--	------	---	--------	---	------	---	---