

# EQUALIZER

design lbrand

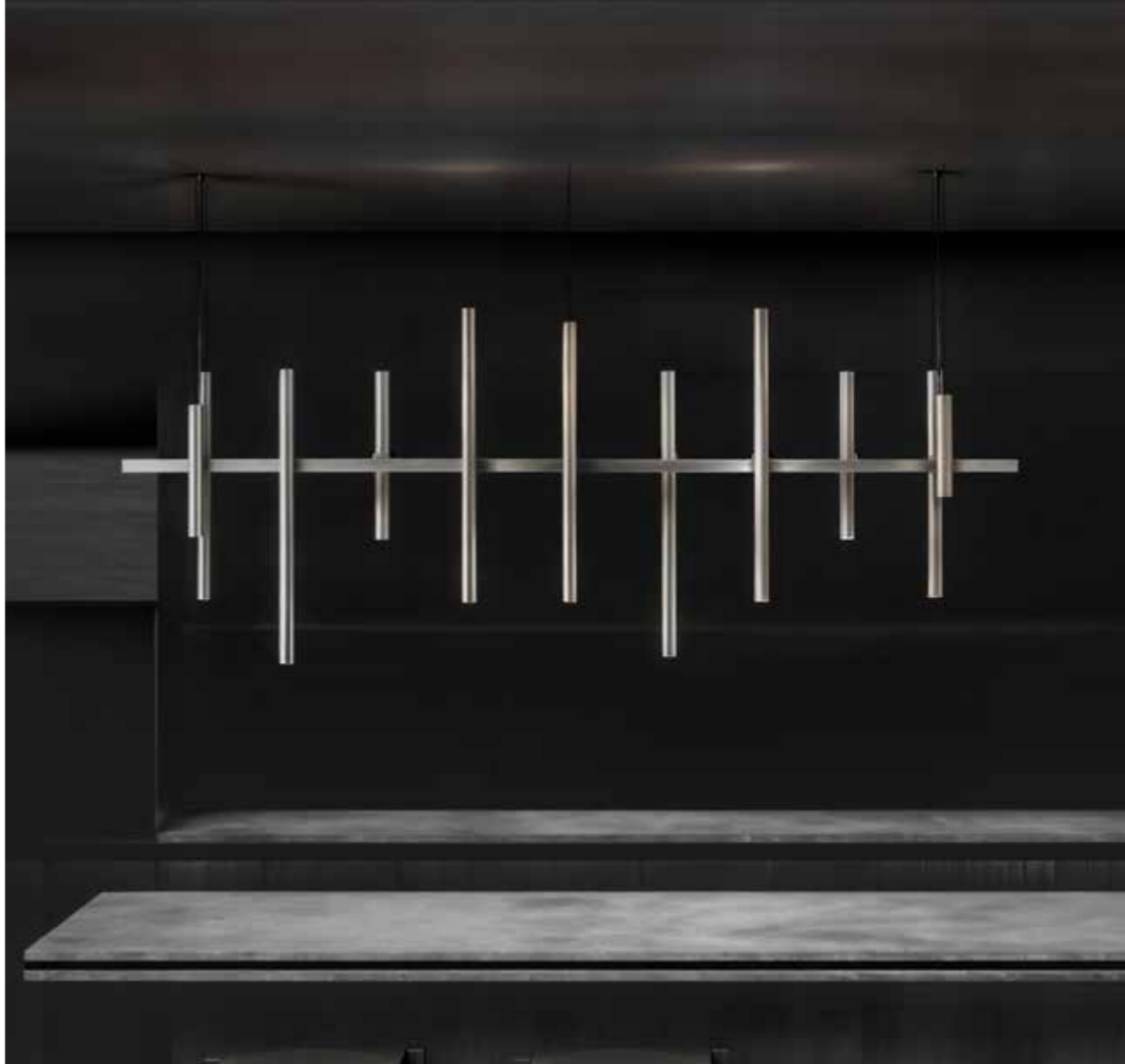





Chalet Vanipoul - Skialux



**EQUALIZER 1600**  
3501-BB(B)-903H-DD-K-L-MM

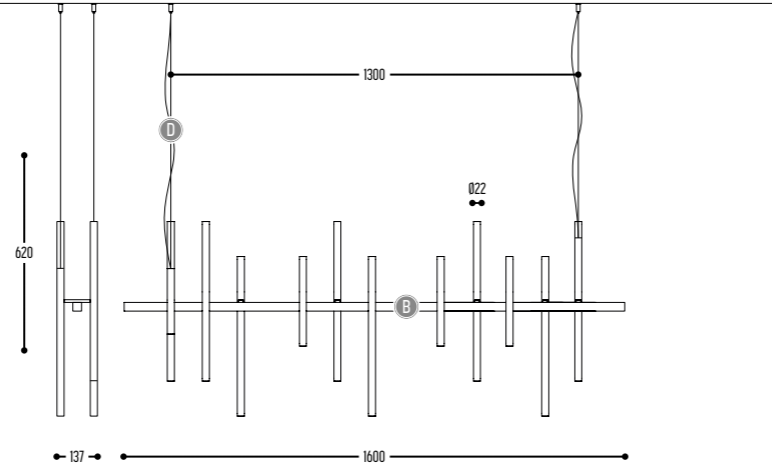

BB(B)	COLORS	02	Black		
		03	White		
		10	Alu		
		150	Bronze Light		
		151	Bronze Dark		
EFF	CRI • LUMENOUTPUT	903	>90 CRI • 350 mA / 3,5 W		
		H	COLOR TEMP.	2	2700K
				3	3000K
DD	SUSP. CABLE	01	1,5 m		
		02	2,5 m		
K	DRIVER	0	Non dimmable (extern)		
		3	Dali / Push Dim (extern)		
L	LIGHTING	1	down (1 driver extern) 9x 280 Lm		
		2	up/down (2 drivers extern) 18x 280 Lm		
MM	TYPE	01	1600 Concrete ceiling - driver remote - down		
		02	1600 Concrete ceiling - driver remote - up/down		
		03	1600 Concrete ceiling - driver in ceiling base - down		
		04	1600 Concrete ceiling - driver in ceiling base - up/down		
		05	1600 Plaster board - driver recessed in base - down		
		06	1600 Plaster board - driver recessed in base - up/down		
		07	1600 Plaster board - driver remote - down		
		08	1600 Plaster board - driver remote - up/down		



**2500**  
3500-BB(B)-903H-DD-K-L-MM

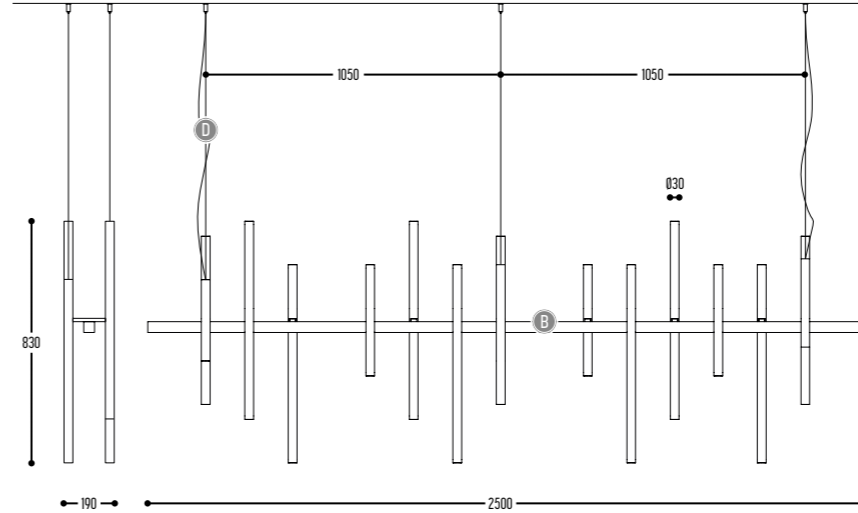

BB(B)	COLORS	02	Black		
		03	White		
		10	Alu		
		150	Bronze Light		
		151	Bronze Dark		
EFF	CRI • LUMENOUTPUT	903	>90 CRI • 350 mA / 6,4 W		
		H	COLOR TEMP.	2	2700K
				3	3000K
DD	SUSP. CABLE	01	1,5 m		
		02	2,5 m		
K	DRIVER	0	Non dimmable (extern)		
		3	Dali / Push Dim (extern)		
L	LIGHTING	1	down (1 driver extern) 10x 420 Lm		
		2	up/down (2 drivers extern) 20x 420 Lm		
MM	TYPE	01	2500 Concrete ceiling - driver remote - down		
		02	2500 Concrete ceiling - driver remote - up/down		
		03	2500 Concrete ceiling - driver in ceiling base - down		
		04	2500 Concrete ceiling - driver in ceiling base - up/down		
		05	2500 Plaster board - driver recessed in base - down		
		06	2500 Plaster board - driver recessed in base - up/down		
		07	2500 Plaster board - driver remote - down		
		08	2500 Plaster board - driver remote - up/down		



CONCRETE CEILING  
DRIVER REMOTE

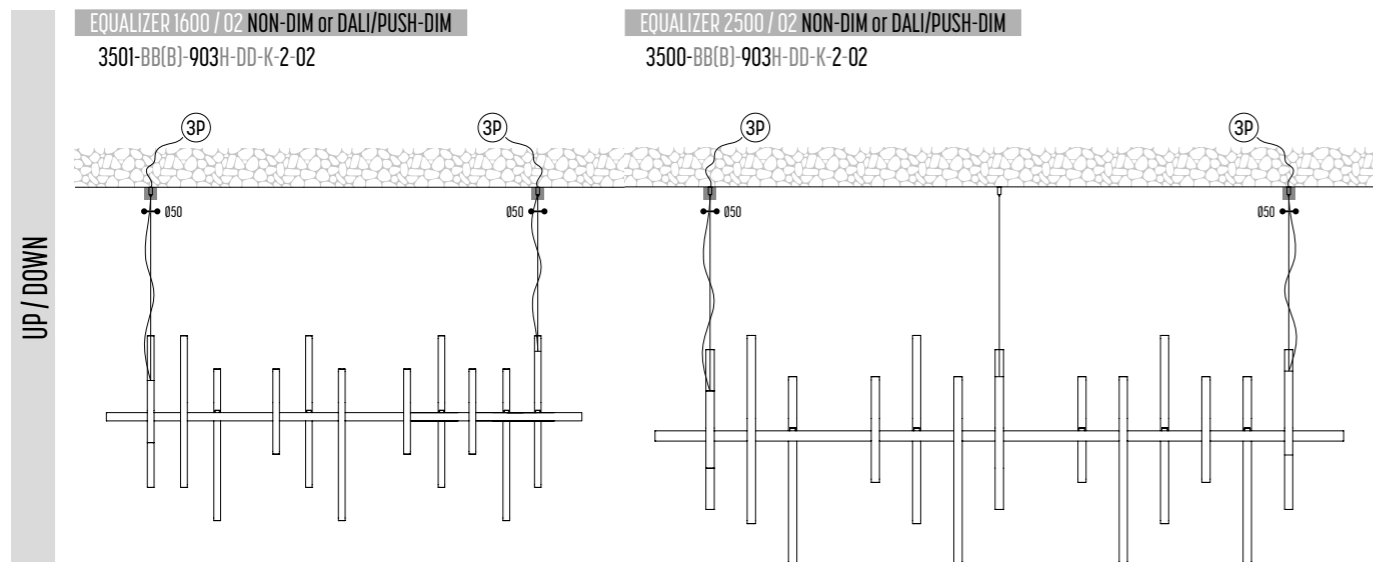
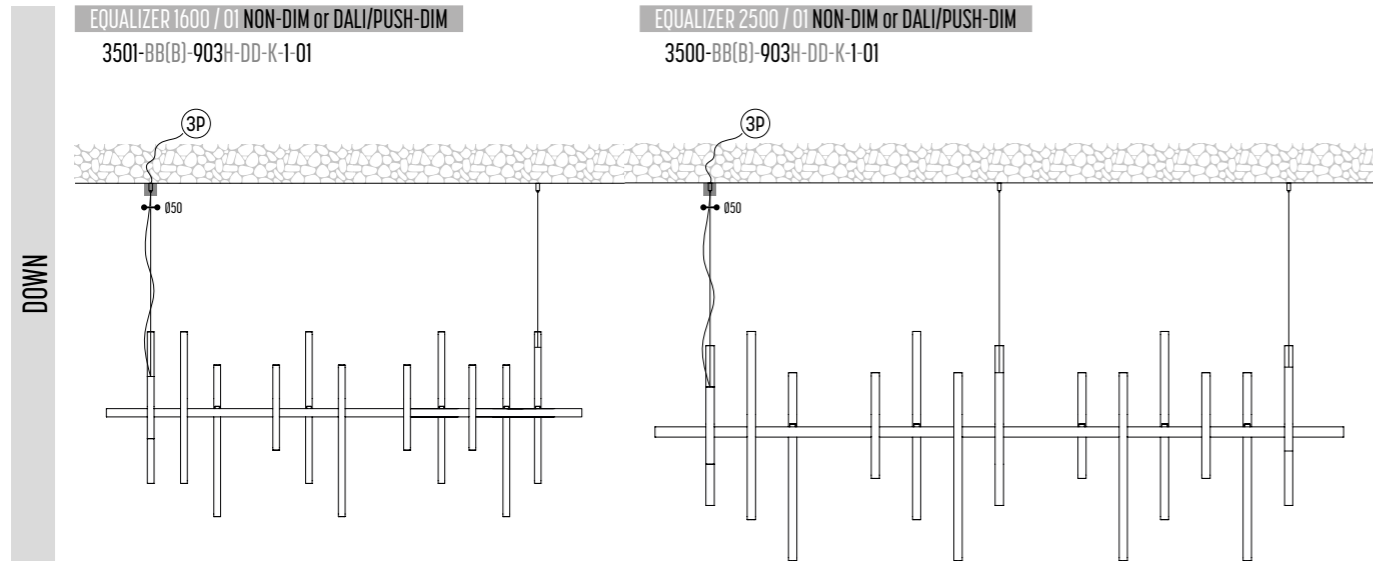

CONCRETE CEILING  
DRIVER IN CEILING BASE

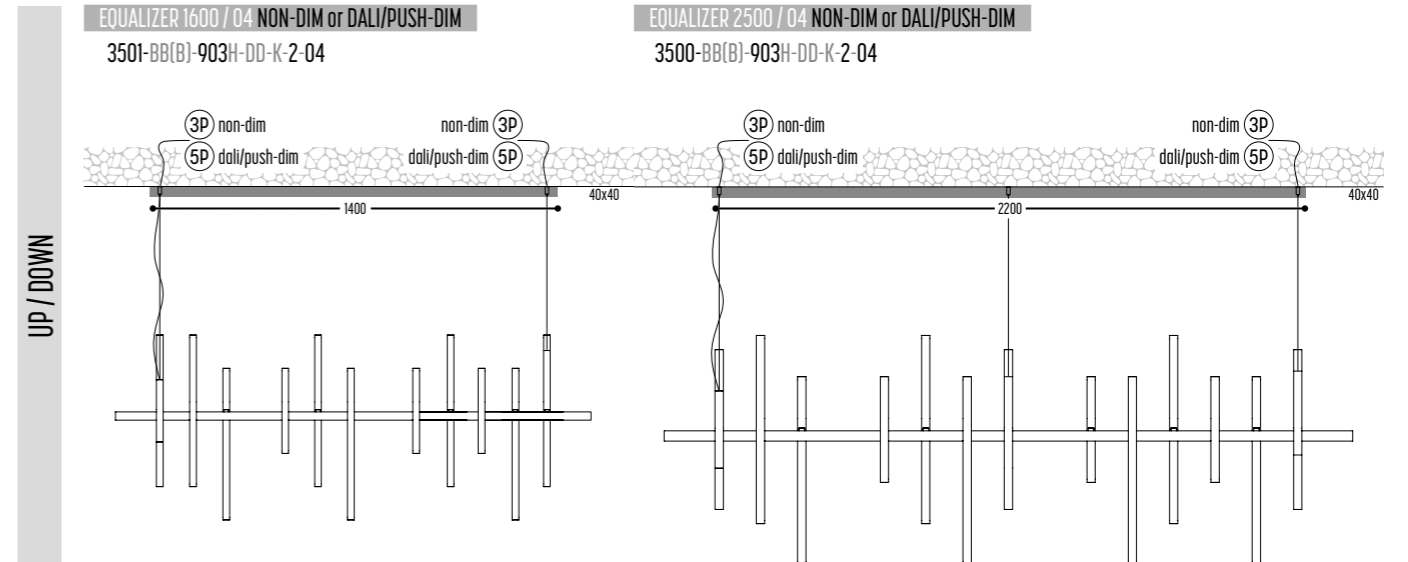
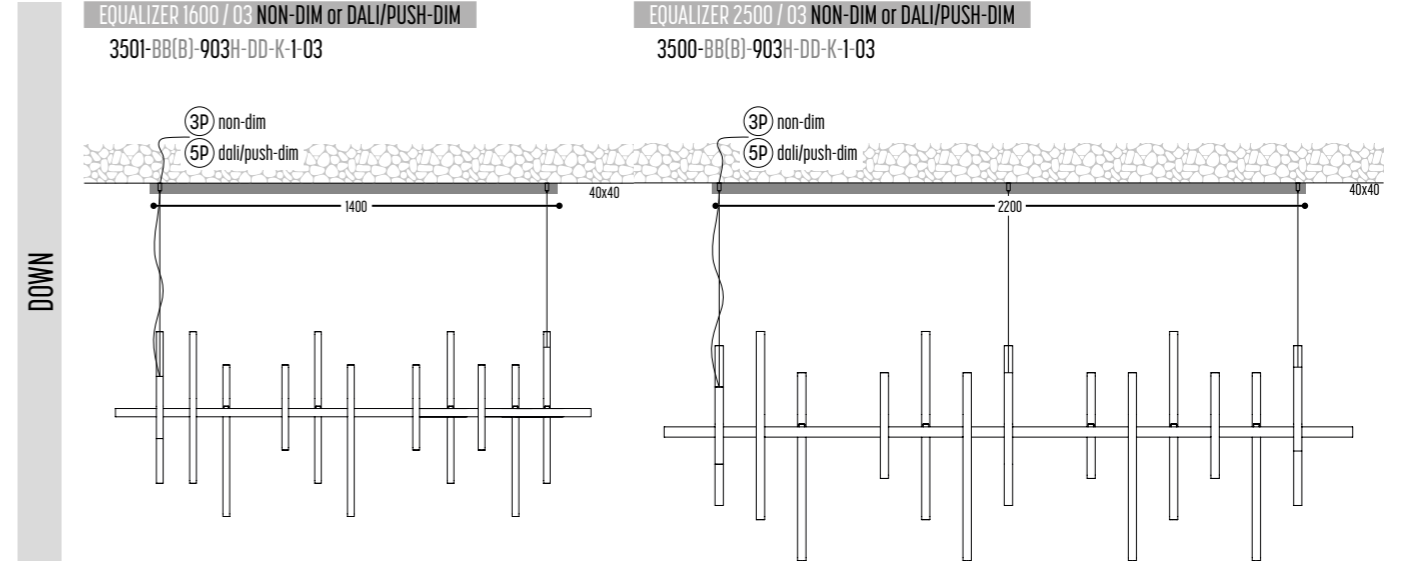

PLASTERBOARD – BA13  
DRIVER RECESSED IN BASE

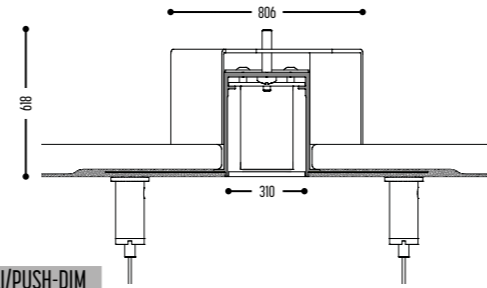

EQUALIZER 1600 / 05 NON-DIM or DALI/PUSH-DIM  
3501-BB(B)-903H-DD-K-1-05

EQUALIZER 2500 / 05 NON-DIM or DALI/PUSH-DIM  
3500-BB(B)-903H-DD-K-1-05

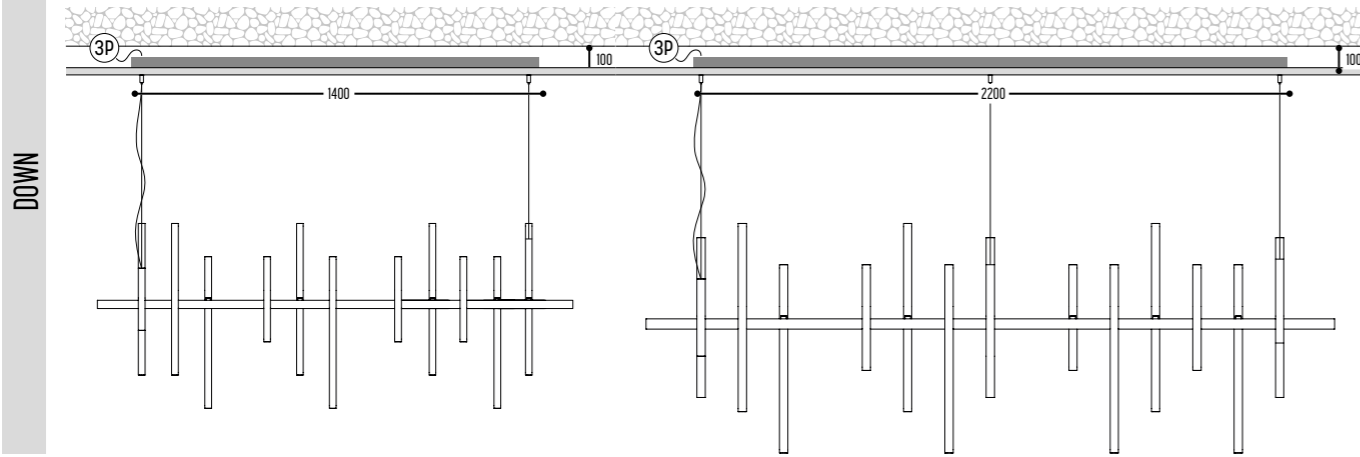

EQUALIZER 1600 / 06 NON-DIM or DALI/PUSH-DIM  
3501-BB(B)-903H-DD-K-2-06

EQUALIZER 2500 / 06 NON-DIM or DALI/PUSH-DIM  
3500-BB(B)-903H-DD-K-2-06

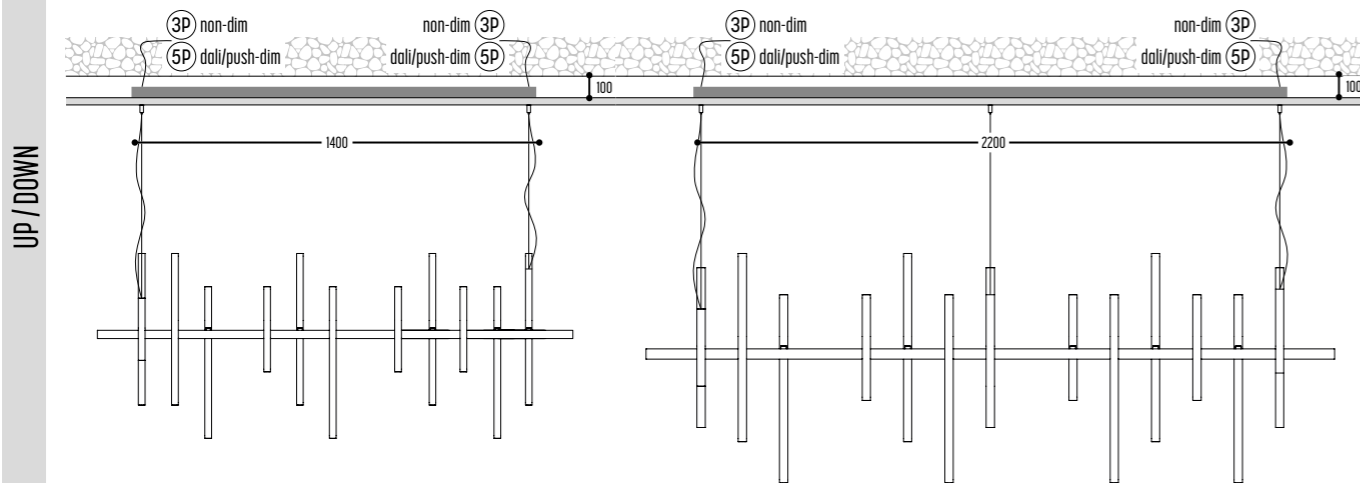

PLASTERBOARD – BA13  
DRIVER REMOTE

EQUALIZER 1600 / 07 NON-DIM or DALI/PUSH-DIM  
3501-BB(B)-903H-DD-K-1-07

EQUALIZER 2500 / 07 NON-DIM or DALI/PUSH-DIM  
3500-BB(B)-903H-DD-K-1-07

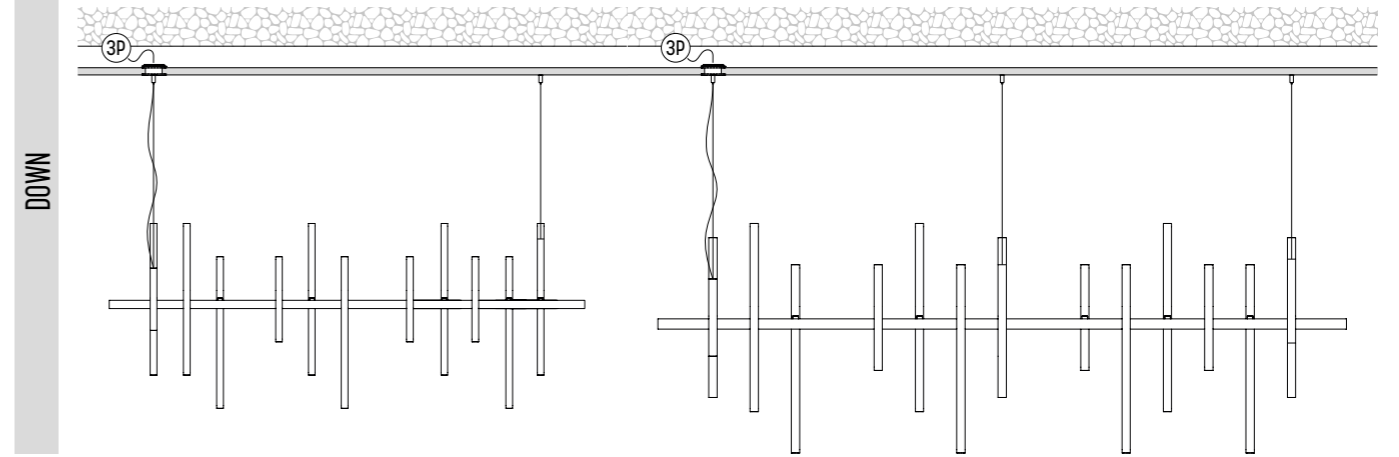

EQUALIZER 1600 / 08 NON-DIM or DALI/PUSH-DIM  
3501-BB(B)-903H-DD-K-2-08

EQUALIZER 2500 / 08 NON-DIM or DALI/PUSH-DIM  
3500-BB(B)-903H-DD-K-2-08

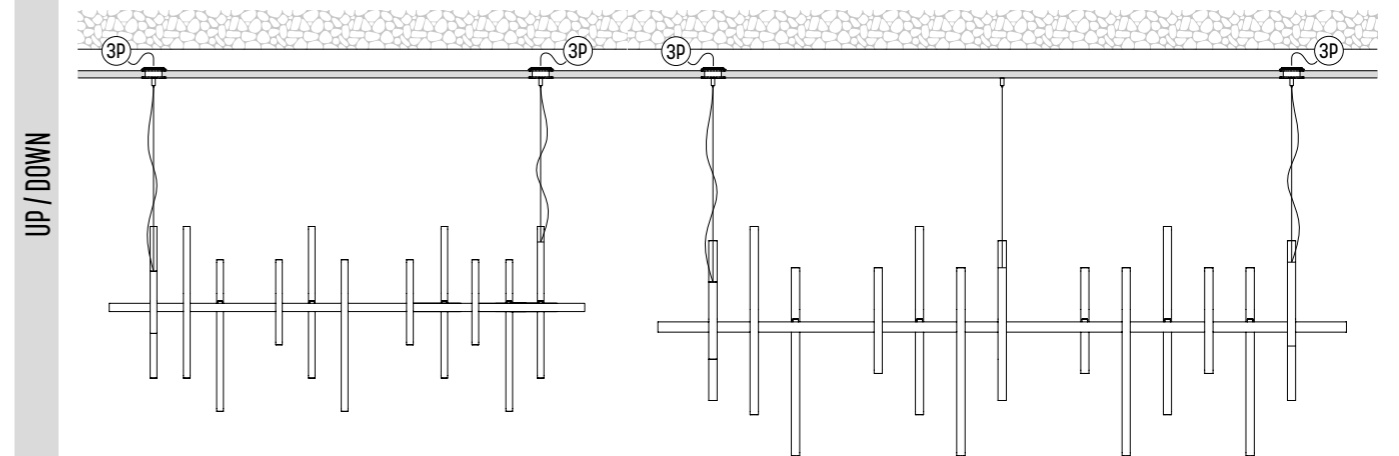



BB(B)	COLORS	02	Black
		03	White
		10	Alu
		150	Bronze Light
		151	Bronze Dark
EFF	CRI • LUMENOUTPUT	903	>90 CRI • 350 Lm / 350 mA / 3,5 W
		2	2700K
		3	3000K
K	DRIVER	0	Non dimmable (extern/intern)
		3	Dali (extern/intern)
		4	Phase cut (extern/intern)



EQUALIZER WALL

3502-BB(B)-903H-K

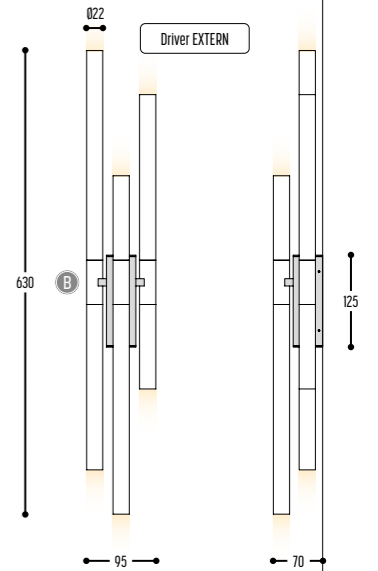

EQUALIZER WALL

3502-BB(B)-903H-K-IN

